

STL mini

15 W Recessed Mounted Single Module
Linear LED Luminaire

Order Code : 3095572
Product Code : STL 016A 40OD00 1K4 120TK3I LN4XMN



Product Data

Standard Features

Housing	: RAL 7047 Powder finished aluminum extrusion housing, aluminum injection cover
Diffuser	: Glare minimizing highly permeable diffuser
Ceiling Type	: Plasterboard
IP Grade	: IP40
Installation	: Recessed mounted
Light Source	: Mid Power LED

Optical & Electrical Features

Power Consumption	: 15.6 W
Final Luminous Flux	: 1575.9 lm
Efficacy	: 101.3 lm/W
Input Voltage	: 220-240 V AC
Frequency	: 50-60 Hz
Power Factor	: > 0,9
Surge Transient Protection	: 1 kV
Drive Current	: 400 mA
Correlated Color Temperature	: 4000K
Color Rendering Index	: >80

*There is ±%10 tolerance in the technical values.

Other Features & Conditions

Operating Temperature Range	: -25 °C/+40 °C
Operating Temperature Range With Emergency Kit	: +5 °C/+35 °C
Impact Resistance	: IK02
Led Life Time - L70	: > 72.000 hours @Ta= 40 °C

Photometric Curve

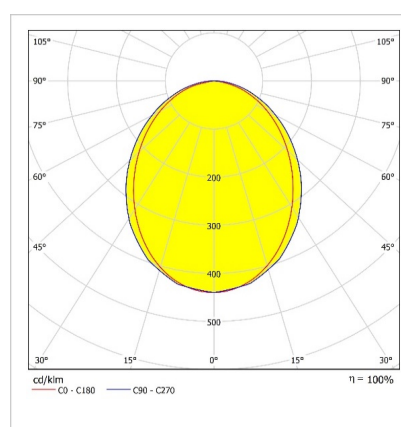

Optional Features

Correlated Color Temperatures	: 2700K, 3000K
Emergency Kit Options	: 1, 3 hours
DALI Option	: Yes
Color Option	: RAL 9005

STL mini

15 W Recessed Mounted Single Module Linear LED Luminaire

3095572 STL 016A 40OD00 1K4 120TK3I LN4XMN

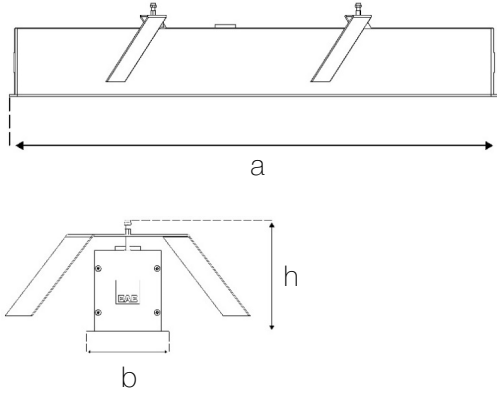

Dimensions (mm)

	a	b	h	d ¹ , d ²
Single Module	1225	70	120	1211x58
Starting Module	1211	70	120	1205x58
Finishing Module	1211	70	120	1205x58
Intermediate Module	1201	70	120	1201x58
Horizontal Rotation	638	70	120	630x58
Vertical Rotation	656	70	120	571x58

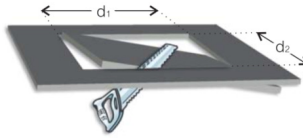

Weight (kg)

Standard	3,9
Horizontal-Vertical Rotation	4
With Emergency Kit (1 hr.)	4,3
With Emergency Kit (3 hrs.)	4,3

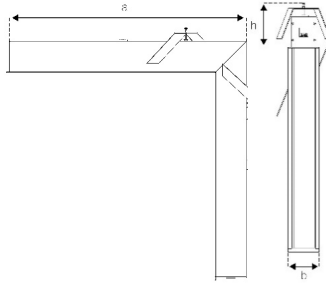

Vertical Rotation

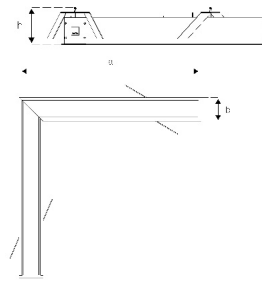

Horizontal Rotation



Installation System

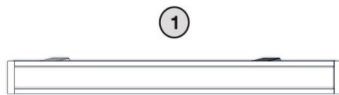

Single (TK)

1

Ordering Code : 3095572
Product Code : STL 016A 40OD00 1K4
120TK3I LN4XMN
Module Model : Single (TK)

2

Ordering Code : 3095570
Product Code : STL 016A 40OD00 1K4
120BS3I LN4XMN
Module Model : Starting (BS)

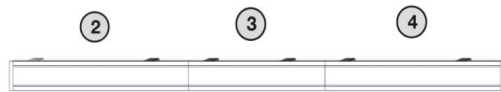

Starting (BS) Intermediate (AR) Finishing (SN)

3

Ordering Code : 3095569
Product Code : STL 016A 40OD00 1K4
120AR3I LN4XMN
Module Model : Intermediate (AR)

4

Ordering Code : 3095571
Product Code : STL 016A 40OD00 1K4
120SN3I LN4XMN
Module Model : Finishing (SN)



Starting (BS) Finishing (SN)

- EAE, reserves the right to make changes without prior notice.



Revision date: 09.02.2020