

## STL mini

33 W Recessed Mounted Single Module  
Linear LED Luminaire

Order Code : 3095836  
Product Code : STL 032A 40OD00 3K2 120TK3I LN4XMN



### Product Data

#### Standard Features

Housing	: RAL 7047 Powder finished aluminum extrusion housing, aluminum injection cover
Diffuser	: Glare minimizing highly permeable diffuser
Ceiling Type	: Plasterboard
IP Grade	: IP40
Installation	: Recessed mounted
Light Source	: Mid Power LED

#### Optical & Electrical Features

Power Consumption	: 33.1 W
Final Luminous Flux	: 3247 lm
Efficacy	: 97.8 lm/W
Input Voltage	: 220-240 V AC
Frequency	: 50-60 Hz
Power Factor	: > 0,9
Surge Transient Protection	: 1 kV
Drive Current	: 800 mA
Correlated Color Temperature	: 4000K
Color Rendering Index	: >80

\*There is  $\pm 10\%$  tolerance in the technical values.

#### Other Features & Conditions

Operating Temperature Range	: -25 °C/+40 °C
Operating Temperature Range With Emergency Kit	: +5 °C/+35 °C
Impact Resistance	: IK02
Led Life Time - L70	: > 72.000 hours @Ta= 40 °C

### Photometric Curve

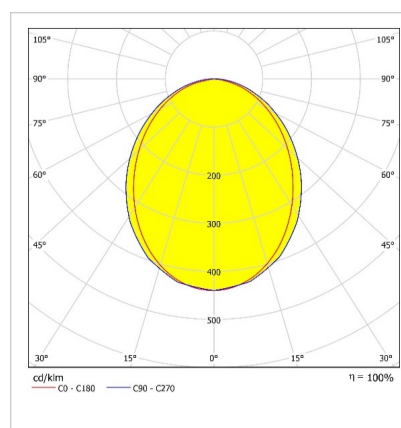

#### Optional Features

Correlated Color Temperatures	: 2700K, 3000K
Emergency Kit Options	: 1, 3 hours
DALI Option	: Yes
Color Option	: RAL 9005

## STL mini

33 W Recessed Mounted Single Module Linear LED Luminaire

3095836 STL 032A 40OD00 3K2 120TK3I LN4XMN

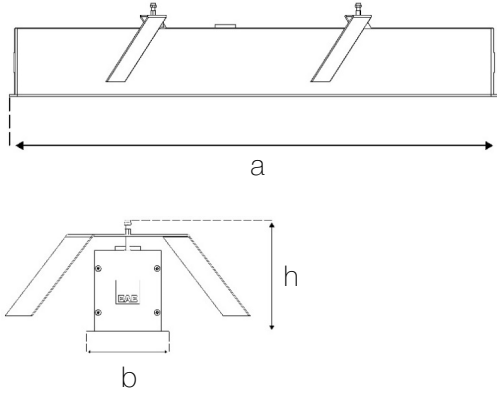

Dimensions (mm)

	a	b	h	d <sup>1</sup> , d <sup>2</sup>
Single Module	1225	70	120	1211x58
Starting Module	1211	70	120	1205x58
Finishing Module	1211	70	120	1205x58
Intermediate Module	1201	70	120	1201x58
Horizontal Rotation	638	70	120	630x58
Vertical Rotation	656	70	120	571x58

Weight (kg)

Standard	3,9
Horizontal-Vertical Rotation	4
With Emergency Kit (1 hr.)	4,3
With Emergency Kit (3 hrs.)	4,3

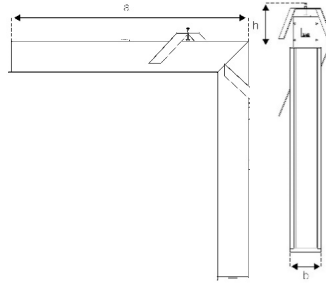
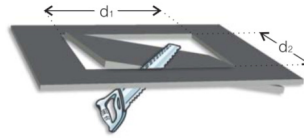

Vertical Rotation

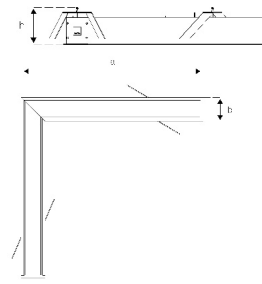

Horizontal Rotation



### Installation System

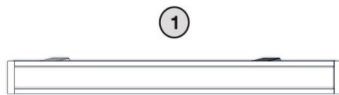

Single (TK)

1

Ordering Code : 3095836  
Product Code : STL 032A 40OD00 2K8  
120TK3I LN4XMN  
Module Model : Single (TK)

2

Ordering Code : 3095834  
Product Code : STL 032A 40OD00 2K8  
120BS3I LN4XMN  
Module Model : Starting (BS)

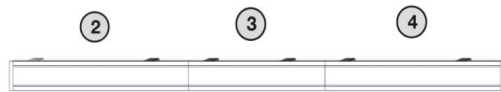

Starting (BS) Intermediate (AR) Finishing (SN)

3

Ordering Code : 3095835  
Product Code : STL 032A 40OD00 2K8  
120AR3I LN4XMN  
Module Model : Intermediate (AR)

4

Ordering Code : 3095835  
Product Code : STL 032A 40OD00 2K8  
120SN3I LN4XMN  
Module Model : Finishing (SN)



Starting (BS) Finishing (SN)

- EAE, reserves the right to make changes without prior notice.



Revision date: 09.02.2020